

Q Anti Vibration



Anti Vibration	
Spring Hanger	186
Cup Spring Mount	187
Housed Spring Mount	188
Inertia Base	189
Anti Vibration Hanger	191
Anti Vibration Mount	191
Ribbed Mounting Pad	192
Waffle Pad	192
Square Cell Pad	193
Cork Sandwich Pad	193
Metal Sandwich Pad	194
Ribbed Multi Layer Pad	194
Square Cell Multi Layer Pad	195

Subject to modifications

Spring Hanger



Features and Benefits

- spring hangers are used to isolate suspended sources of both noise and vibration
- suspended mechanical equipment such as air handling units, FCU's, cabinet fans, piping and ductwork in close proximity to rotating mechanical equipment are typical applications of spring hangers
- color coded springs as per load ratings
- outer diameter equal to at least 85% of working height
- springs designed for 50% overload capacity
- brackets and springs powder coated
- designed to meet BS1726, class B

Part No.	R	L	B (mm)	H (mm)	d1 (mm)	FH (mm)	Deflection (mm)	Fa,z Colour (N)
DM SH2 5 /10	M10	60 mm	52	104	10.5	80	25	100 Red
DM SH2 5 /15	M10	60 mm	52	104	10.5	80	25	150 Purple
DM SH2 5 /20	M10	60 mm	52	104	10.5	80	25	200 Grey
DM SH2 5 /30	M10	60 mm	52	104	10.5	80	25	300 Green
DM SH2 5 /40	M10	60 mm	52	104	10.5	80	25	400 Blue
DM SH2 5 /60	M12	87 mm	65	138	12.5	96	25	600 Yellow
DM SH25 / 100	M12	87 mm	65	138	12.5	96	25	1,000 Black
DM SH25 / 160	M12	87 mm	65	138	12.5	96	25	1,600 White
DM SH25 / 200	M12	87 mm	65	138	12.5	96	25	2,000 Green
DM SH25 / 250	M12	87 mm	65	138	12.5	96	25	2,500 Blue
DM SH25 / 300	M16	100 mm	85	157	16.5	115	25	3,000 Red
DM SH25 / 400	M16	100 mm	85	157	16.5	115	25	4,000 Purple
DM SH25 / 500	M16	100 mm	85	157	16.5	115	25	5,000 Grey
DM SH25 / 600	M16	100 mm	85	157	16.5	115	25	6,000 Green
DM SH25 / 800	M16	100 mm	85	157	16.5	115	25	8,000 Blue
DMSH25/1050	M16	100 mm	85	157	16.5	115	25	10,500 Yellow
DMSH25/1250	M16	100 mm	85	157	16.5	115	25	12,500 Black

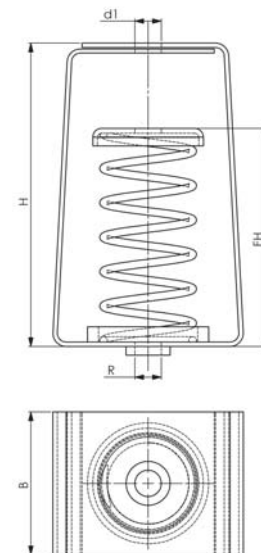

Subject to modifications

Cup Spring Mount

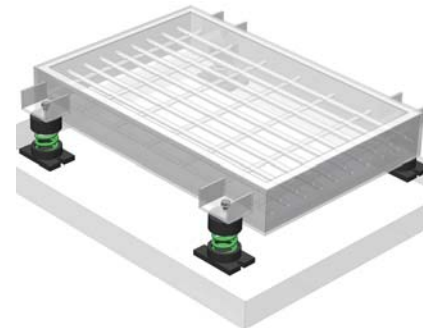

Features and Benefits

- Cup Spring Mounts are used to isolate noise and vibration from floor mounting equipments
- pumps, packaged air handling units, air conditioning units, centrifugal and axial fans, inertia bases etc.
- color coded springs as per load ratings
- outer diameter equal to at least 85% of working height
- springs designed for 50% overload capacity
- neoprene top and bottom with non-skid bolt down base
- plated leveling / lock bolt
- springs powder coated
- designed to meet BS1726, class B

Part No.	Bolt	L	B (mm)	d1 (mm)	k (mm)	FH (mm)	Deflection (mm)	Fa,z Colour (N)
DM CS2 5 -10	M16	110 mm	65	M10	90	115	25	100 Red
DM CS2 5 -15	M16	110 mm	65	M10	90	115	25	150 Purple
DM CS2 5 -20	M16	110 mm	65	M10	90	115	25	200 Grey
DM CS2 5 -30	M16	110 mm	65	M10	90	115	25	300 Green
DM CS2 5 -40	M16	110 mm	65	M10	90	115	25	400 Blue
DM CS2 5 -60	M16	110 mm	75	M10	90	125	25	600 Yellow
DM CS25 - 100	M16	110 mm	75	M10	90	125	25	1,000 Black
DM CS25 - 160	M16	110 mm	75	M10	90	125	25	1,600 White
DM CS25 - 200	M16	110 mm	75	M10	90	125	25	2,000 Green
DM CS25 - 250	M16	110 mm	75	M10	90	125	25	2,500 Blue
DM CS25 - 300	M20	140 mm	100	M12	120	168	25	3,000 Red
DM CS25 - 400	M20	140 mm	100	M12	120	168	25	4,000 Purple
DM CS25 - 500	M20	140 mm	100	M12	120	168	25	5,000 Grey
DM CS25 - 600	M20	140 mm	100	M12	120	168	25	6,000 Green
DM CS25-800	M20	140 mm	100	M12	120	168	25	8,000 Blue
DMCS25-1050	M20	140 mm	100	M12	120	168	25	10,500 Yellow
DMCS25-1250	M20	140 mm	100	M12	120	168	25	12,500 Black

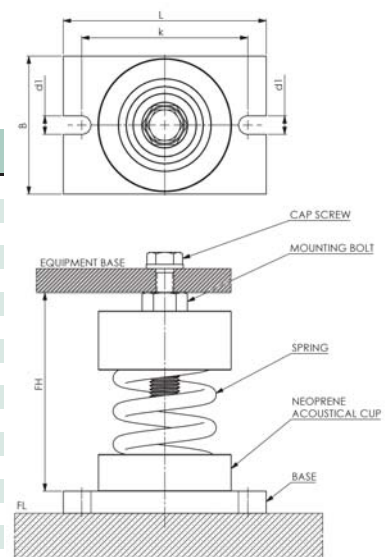

Housed Spring Mount

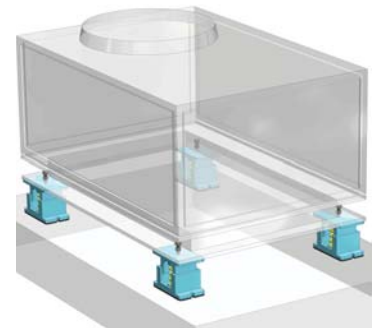

Features and Benefits

- Housed Spring Mount design provides horizontal stability, high loading capacity and protective spring enclosure
- all mounts have external leveling arrangement, capable of compensating for full static deflection
- inner walls of lower casing have resilient rubber snubbers
- deflection is at rated load with 15% tolerance
- all mounts have approximately 50% overload capacity
- mountings must be adjusted so that upper housing clears lower housing by at least 6 mm and not more than 12 mm
- application examples include: chiller, AHU's, pumps, centrifugal / axial fans, condensing units, roof top packaged units, reciprocating compressors, DG sets, punch presses, drop hammers and floor pipe supports (normally at first few pipe support points leading from isolated equipment)
- springs powder coated
- designed to meet BS1726, class B

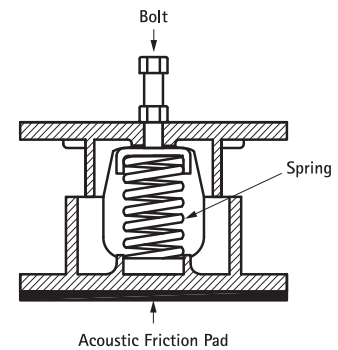

Part No.	Bolt	L	B	s	d1	k	FH	Deflection	Fa,z	Colour
		(mm)	(mm)	(mm)	(mm)	(mm)	(mm)	(mm)	(N)	
DMHS 1 - 60	M12	160 mm	92	5.0	∅ 10.0	147	116	25	600	Yellow
DM HS1 - 100	M12	160 mm	92	5	∅ 10.0	147	116	25	1,000	Black
DM HS1 - 160	M12	160 mm	92	5	∅ 10.0	147	116	25	1,600	White
DM HS1 - 200	M12	160 mm	92	5	∅ 10.0	147	116	25	2,000	Green
DM HS1 - 250	M12	160 mm	92	5	∅ 10.0	147	116	25	2,500	Blue
DM HS1A - 300	M16	200 mm	115	10	∅ 12.0	180	158	25	3,000	Red
DM HS1A - 400	M16	200 mm	115	10	∅ 12.0	180	158	25	4,000	Purple
DM HS1A - 500	M16	200 mm	115	5	∅ 12.0	147	116	25	5,000	Grey
DM HS1A - 600	M16	200 mm	115	10	∅ 12.0	180	158	25	6,000	Green
DM HS1A - 800	M16	200 mm	115	10	∅ 12.0	180	158	25	8,000	Blue
DMHS1A-1050	M16	200 mm	115	10	∅ 12.0	180	158	25	10,500	Yellow
DMHS1A-1250	M16	200 mm	115	10	∅ 12.0	180	158	25	12,500	Black
DM HS2 - 600	M20	285 mm	115	10	∅ 16.0	265	163	25	6,000	Red
DM HS2 - 800	M20	285 mm	115	10	∅ 16.0	265	163	25	8,000	Purple
DM HS2- 1 000	M20	285 mm	115	10	∅ 16.0	265	163	25	10,000	Grey
DM HS2- 1 200	M20	285 mm	115	10	∅ 16.0	265	163	25	12,000	Green
DM HS2- 1 600	M20	285 mm	115	10	∅ 16.0	265	163	25	16,000	Blue
DM HS2- 2 100	M20	285 mm	115	10	∅ 16.0	265	163	25	21,000	Yellow
DM HS2- 2 500	M20	285 mm	115	10	∅ 16.0	265	163	25	25,000	Black
DM HS4- 1 200	M20	285 mm	210	10	∅ 16.0	265	163	25	12,000	Red
DM HS4- 1 600	M20	285 mm	210	10	∅ 16.0	265	163	25	16,000	Purple
DM HS4- 2 000	M20	285 mm	210	10	∅ 16.0	265	163	25	20,000	Grey
DM HS4- 2 400	M20	285 mm	210	10	∅ 16.0	265	163	25	24,000	Green
DM HS4- 3 200	M20	285 mm	210	10	∅ 16.0	265	163	25	32,000	Blue
DM HS4- 4 200	M20	285 mm	210	10	∅ 16.0	265	163	25	42,000	Yellow
DM HS4- 5 000	M20	285 mm	210	10	∅ 16.0	265	163	25	50,000	Black

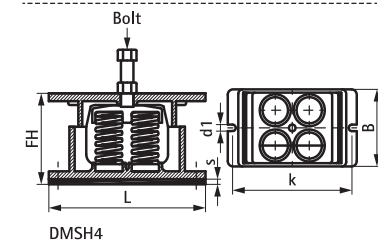
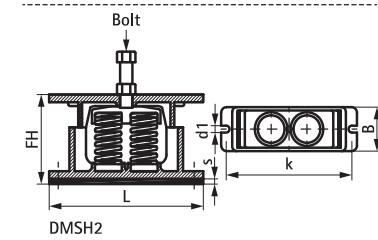
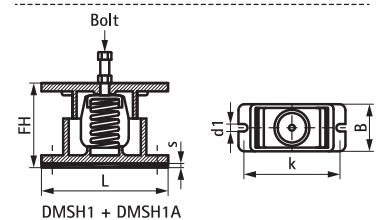

Inertia Base

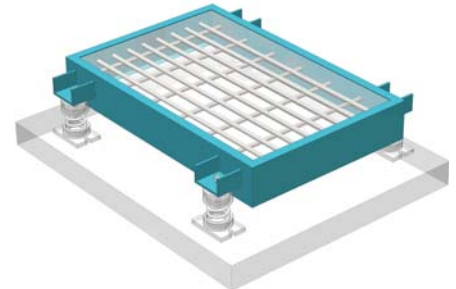
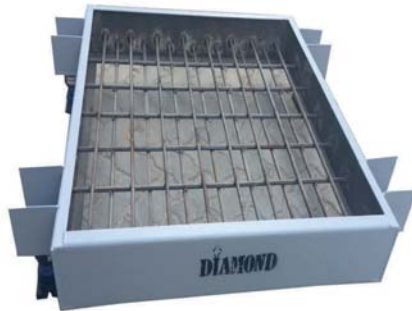

Features and Benefits

- Inertia Base is specially designed and engineered to pour concrete, which after curing is used as mechanical vibration isolated reinforced inertia base for the equipments
- these Inertia Base are recommended to use under heavy start up and shut down vibration amplitude equipments such as generators, IC engines, large fans, centrifugal chillers etc.
- Inertia Base made from standard structural channel or formed steel channel depend upon the design. It is used 12 mm reinforcement rod welded in 150 mm spacing for better concrete strength. Inertia Base is supplied with red oxide primer coating.
- Diamond Walraven Vibration Isolator Spring Mount will be supplied together as per design

Part No.
DMI B 500
DMI B 750
DMIB 1 000
DMIB 1 250
DMIB 1 500
DMIB 1 750
DMIB 2 000
DMIB 2 250
DMIB 2 500
DMIB 2 750
DMIB 3 000

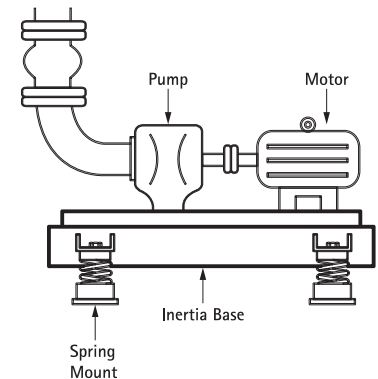

Base Thickness Chart

The length and width dimensions shown include the actual frame size and may not include the length and width of the bracket

Part Number		Base width in mm					
		500	750	1,000	1,250	1,500	1,750
Base length in mm	DMIB500	150	-	-	-	-	-
	DMIB750	150	150	-	-	-	-
	DMIB1000	150	150	150, 200, 250	-	-	-
	DMIB1250	150	150	150, 200, 250	150, 200, 250, 300	-	-
	DMIB1500	150	150, 200	150, 200, 250, 300	150, 200, 250, 300	150, 200, 250, 300	-
	DMIB1750	150	150, 200	150, 200, 250, 300	150, 200, 250, 300	150, 200, 250, 300	150, 200, 250, 300
	DMIB2000	-	150, 200	150, 200, 250, 300	150, 200, 250, 300	150, 200, 250, 300	150, 200, 250, 300
	DMIB2250	-	150, 200	150, 200, 250, 300	150, 200, 250, 300	150, 200, 250, 300	150, 200, 250, 300
	DMIB2500	-	-	150, 200, 250, 300	150, 200, 250, 300	150, 200, 250, 300	150, 200, 250, 300
	DMIB2750	-	-	150, 200, 250, 300	150, 200, 250, 300	150, 200, 250, 300	150, 200, 250, 300
	DMIB3000	-	-	-	150, 200, 250, 300	150, 200, 250, 300	150, 200, 250, 300

Anti Vibration Hanger



Features and Benefits

- constructed of a neoprene element in a square powder coated bracket

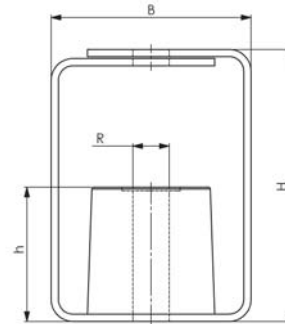

Part No.	R	B (mm)	H (mm)	h (mm)	Deflection (mm)	Fa,z Colour (N)
DMRH10	M10	55	75	40	8	100 Blue
DMRH20	M10	55	75	40	8	200 Green
DMRH30	M10	55	75	40	8	300 Red
DMRH50	M10	55	75	40	8	500 Yellow
DMRH70	M10	55	75	40	10	700 Brown
DMR H 120	M10	55	75	40	10	1,200 Orange

Anti Vibration Mount



Features and Benefits

- constructed of a neoprene element encased within two steel caps electrogalvanized
- compact model for space saving installations
- extended design prevents metal to metal contact

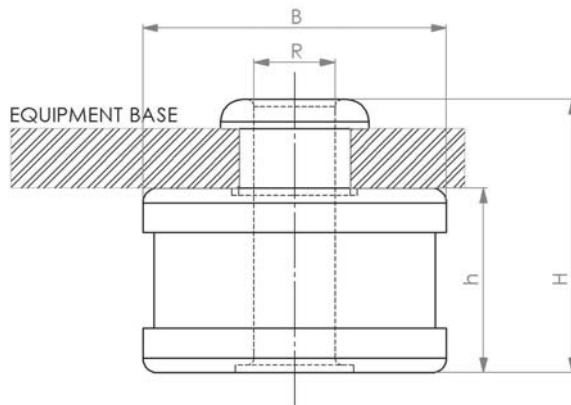

Part No.	R	B (mm)	H (mm)	h (mm)	Deflection (mm)	Fa,z (N)
DMAVM	M10	41	37	25	4	900
DMAVMC	M10	32	27	19	4	600

Ribbed Mounting Pad

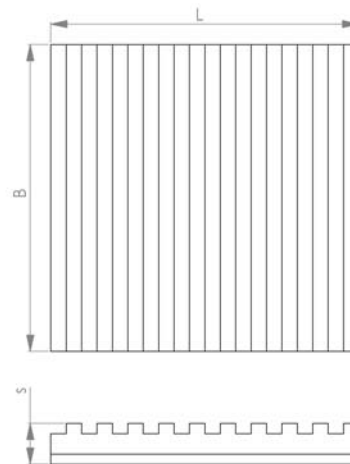

Features and Benefits

- alternate high-low ribbed construction
- pads can be cut to be slightly larger than the size of the leg or machine, using shears or knife
- easy field installation
- multiple layers of Ribbed Mounting Pad can be used to increase deflection

Part No.	L	B (mm)	s (mm)	Rec. Load (N)	Fa,z (N)
HIMOAVP381818	450 mm	450	10	4,100	4,800
HIMOAVP381212	300 mm	300	10	2,750	3,100
HIMOAVP380808	200 mm	200	10	1,800	2,050
HIMOAVP380606	150 mm	150	10	1,350	1,500
HIMOAVP380404	100 mm	100	10	900	1,050
HIMOAVP380303	75 mm	75	10	650	750

Waffle Pad

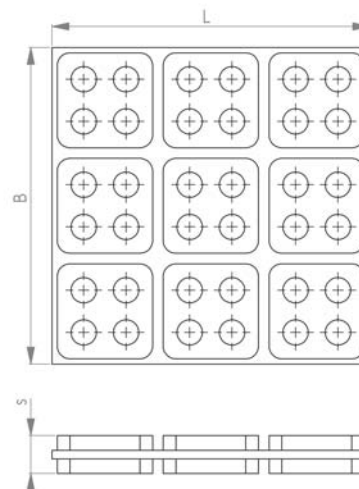

Features and Benefits

- easy field installation
- no need for bolting
- designed with in-built section cups
- easy cut design without tools allows job site flexibility

Part No.	L	B (mm)	s (mm)	Rec. Load (N)	Fa,z (N)
DMAVWP341818	450 mm	450	20	4,100	4,800
DMAVWP341212	300 mm	300	20	2,750	3,100
DMAVWP340808	200 mm	200	20	1,800	2,050
DMAVWP340606	150 mm	150	20	1,350	1,500
DMAVWP340404	100 mm	100	20	900	1,050

Subject to modifications

Square Cell Pad

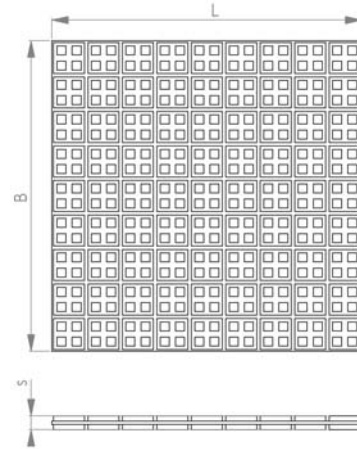

Features and Benefits

- Square Cell Pad consist of 81 sections of size 50 mm x 50 mm separated by a thin web which can be easily cut to fit loading requirements
- excellent high frequency sound attenuation as compared to waffle pads
- standard size for ease of handling

Part No.	L	B	s	Rec. Load	Fa,z
		(mm)	(mm)	(N)	(N)
DMACMSC341818	450 mm	450	20	4,500	6,000

Cork Sandwich Pad

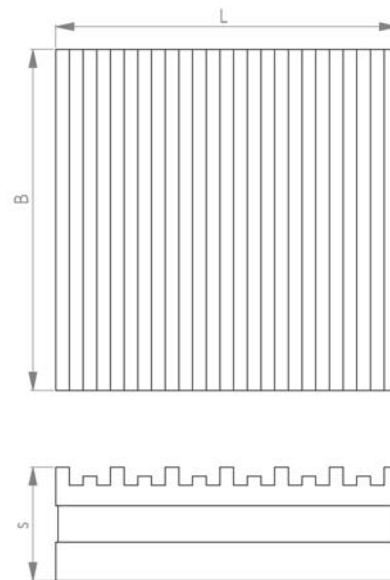

Features and Benefits

- Cork Sandwich Pad are laminated pads having 3/8" thick close grained cork securely bonded between two layers of 1/4" alternate low-high ribbed neoprene rubber pads
- easy field installation
- no need for bolting
- offers highest level of sound attenuation and vibration insulation

Part No.	L	B	s	Rec. Load	Fa,z
		(mm)	(mm)	(N)	(N)
HIMOAVSP781818	450 mm	450	22	7,200	9,000
HIMOAVSP781212	300 mm	300	22	7,200	6,000
HIMOAVSP780808	200 mm	200	22	3,200	4,000
HIMOAVSP780606	150 mm	150	22	2,400	3,000
HIMOAVSP780404	100 mm	100	22	1,600	2,000
HIMOAVSP780303	75 mm	75	22	1,200	1,500

Subject to modifications

Metal Sandwich Pad

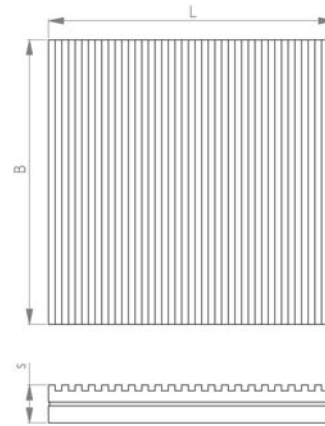

Features and Benefits

- Metal Sandwich Pads are constructed of a steel plate bonded between ribbed and vibration pads
- designed for very high load capacity

Part No.	L	B (mm)	s (mm)	Rec. Load (N)	Fa,z (N)
HIMOAVMP11818	450 mm	450	25	22,000	33,000
HIMOAVMP11212	300 mm	300	25	18,000	27,000
HIMOAVMP10808	200 mm	200	25	15,000	22,500
HIMOAVMP341818	450 mm	450	20	22,000	33,000
HIMOAVMP341212	300 mm	300	20	18,000	27,000
HIMOAVMP340808	200 mm	200	20	15,000	22,500
HIMOAVMP340606	150 mm	150	20	12,500	18,750
HIMOAVMP340404	100 mm	100	20	7,500	11,250
HIMOAVMP340303	75 mm	75	20	6,000	9,000

Ribbed Multi Layer Pad

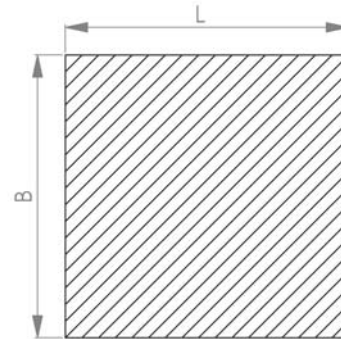

Features and Benefits

- Ribbed Multi Layer Pads are constructed of two layers of thick ribbed pads encasing one 1.5 mm thickness steel plate in the center
- alternate rib design with the ribs below and above joined at right angles to each other to eliminate skidding
- diagonal ribs help to distribute load evenly

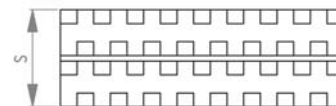

Part No.	L	B (mm)	s (mm)	Deflection (mm)	Rec. Load (N)	Fa,z (N)
HIMOAVMLP1380606	152 mm	152	35	4.5	6,300	9,000
HIMOAVMLP1380404	102 mm	102	35	4.5	2,800	4,000

Square Cell Multi Layer Pad

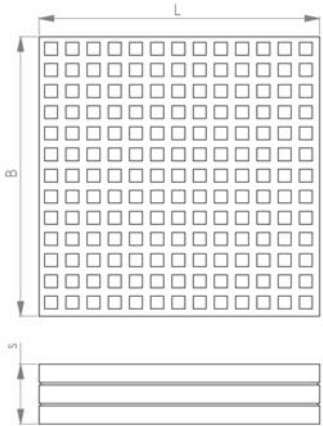

Features and Benefits

- Square Cell Multi Layer Pads are constructed of three layers of square cell rubber sheets with two steel plates of 1.5 mm thickness
- due to suction pockets formed by the square cell design the pad offers better grip on the floor surface
- higher load capacity than Ribbed Multi Layer Pad

Part No.	L	B (mm)	s (mm)	Deflection (mm)	Rec. Load (N)	Fa,z (N)
HIMOAVSCP1380606	152 mm	152	32	4.5	7,900	10,000
HIMOAVSCP1380404	102 mm	102	32	4.5	3,500	4,500

Subject to modifications

Notes

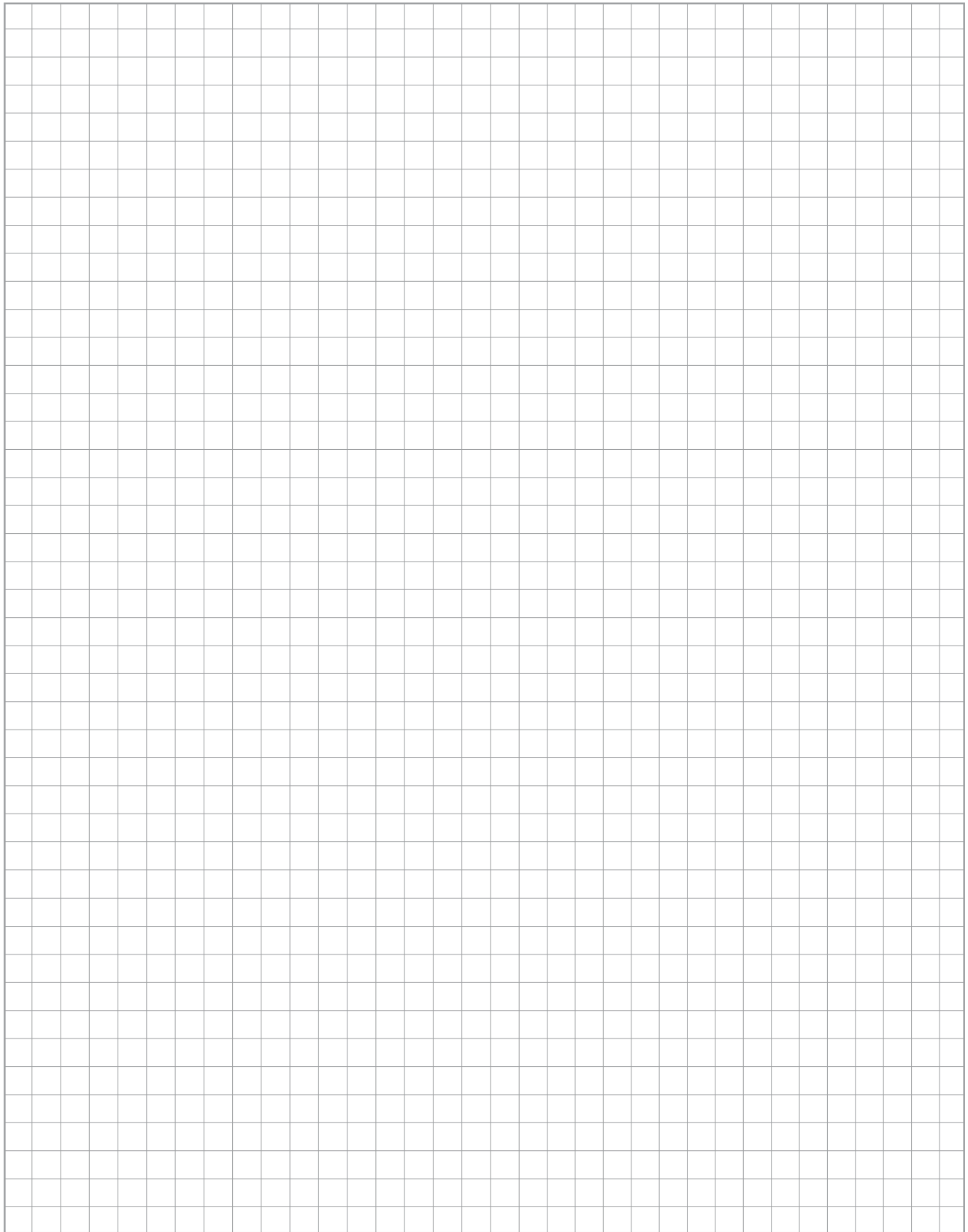
A large grid area for taking notes, consisting of a 20x20 grid of small squares. A small grey square is located to the left of the top-left corner of the grid.

Subject to modifications